

# IFR SERIES













INTERCHANGE > ISO 5676 "NF U 16-006"



Stucchi®



## TECHNICAL FEATURES AND OPTIONS

 <b>Interchange</b> ISO 5676 "NF U 16-006"	 <b>Sealing description</b> Nitrile NBR	 <b>Connection system</b> Single acting sleeve
 <b>Available sizes</b> 3/8"	 <b>Material/treatment</b> Carbon steel /Cr3	 <b>Available threads</b> BSP - METRIC
 <b>Operating pressure</b> Up to 150 bar	 <b>Locking mechanism</b> Locking Ball system	 <b>Flow rate</b> Up to 46 L/Min
 <b>Temperature (°C)</b> -20° / +100°	 <b>Valving style</b> Flat Face - limited spill	 <b>Connection under pressure</b> Connection: not allowed Disconnection: not allowed

## BENEFITS

- Minimal fluid spillage during disconnection, reducing fluid spillage to the environment.
- Minimal air inclusion during connection.
- Compact slim design.
- Simple to use.
- Metallic plug for female and plastic cap for male are included with the couplings.

## HOW TO USE

- Before to connect, clean the mating surface of the couplings to avoid dirt inclusion in the circuit.
- To connect pull back the sleeve of the female coupling, align the female with the male coupling and push one into the other until both halves are fully connected and release the sleeve.
- To disconnect push back the sleeve of the female coupling, pull out the mating half.

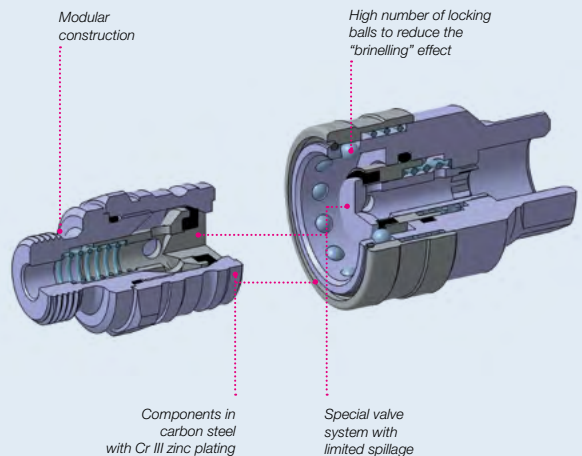
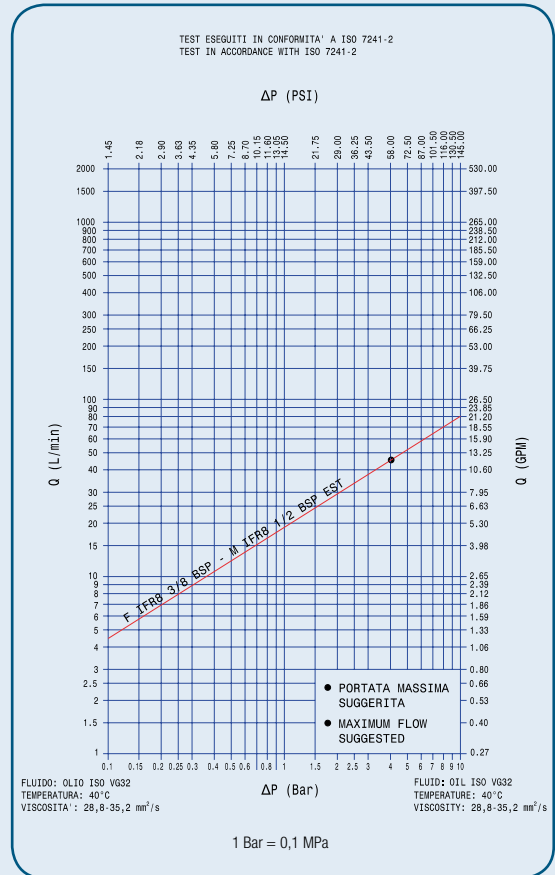

## MAIN APPLICATIONS



OTHER INTERCHANGE



## PERFORMANCES

Size		Series/Size	Max. flow suggested		Connect force		Disconnect force		Spillage*
Inch	mm		l/min	GPM	N	lbf	N	lbf	ml
3/8	6,3	IFR8	46	12,15	170	38,25	27	6,08	0,06

Size	Series/Size	Max. operating pressure						Burst pressure					
		Coupled		Male		Female		Coupled		Male		Female	
		MPa	psi	MPa	psi	MPa	psi	MPa	psi	MPa	psi	MPa	psi
3/8	IFR8	15	2175	15	2175	15	2175	100	14500	80	11600	30	4350

\*Spillage is an indicative value of the fluid loss during disconnection (according to ISO 7241-2 test method)

### Temperature range:

Standard seal - NBR (Nitrile): from -20 °C to +100 °C ( from -4 °F to +212 °F).  
Please read carefully "instruction and warning" for proper selection of the products.

### Tests:

The couplings have been tested at max. operating pressure for 100.000 impulses according to ISO 7241-2 test method.



## WARNING

A defect, a wrong choice or an improper use of products, can cause injury to persons, animals and objects.  
Connection under pressure are under residual pressure.

Never connect or disconnect with dynamic pressure (e.g. pump on).

Do not use the coupling disconnected with high impulse pressure.

Do not couple-uncouple with flow and/or pressure in the circuit.

Do not couple-uncouple when the temperature inside of the circuit is higher than 80 °C (176 °F).

Check the maximum allowable working pressure of the port in use.

Make sure that the medium used is compatible with seal and material as indicated for each series.

In case of doubt please contact Stucchi Technical Support.

The interchangeability is mentioned under the assumption that the manufacturer of the considered products has not changed any dimension.

**It is MANDATORY to read and closely follow the instructions. Last updated version always apply at time of installation, see latest written Instructions on Stucchi website ([www.stucchi.it](http://www.stucchi.it)) before selecting or using Stucchi products.**

## OVERALL DIMENSIONS

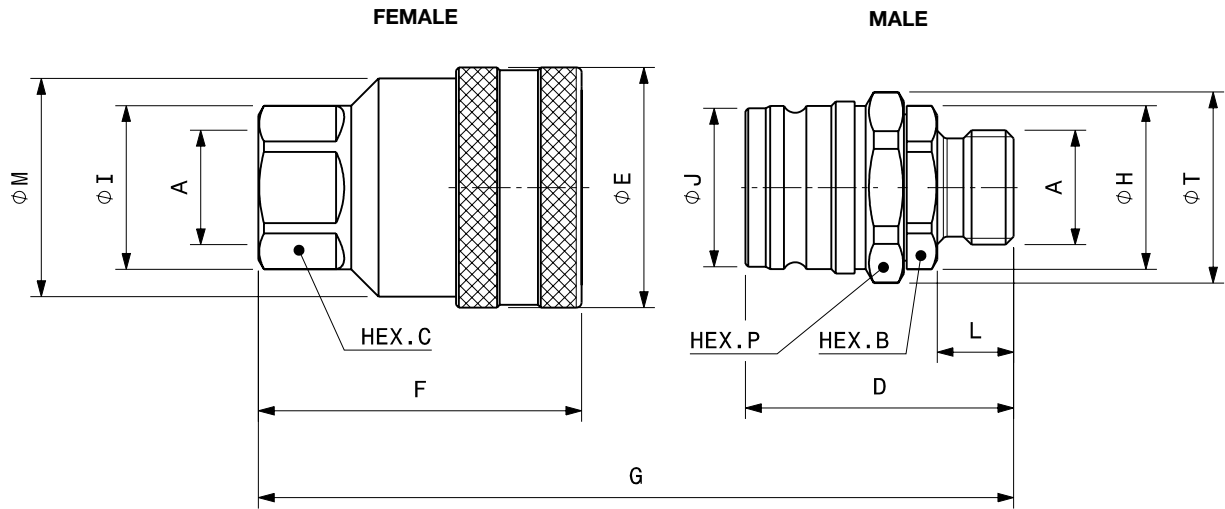

### Port description: FEMALE THREAD BSPP (ISO 1179-1) FEMALE THREAD METRIC

BODY SIZE	Descriptive Code	Item Code	ISO DN	PORT (A)	Overall Length		Length		Hex		Diameter		Diameter		Diameter							
					mm	inch	mm	inch	mm	inch	mm	inch	mm	inch	mm	inch						
3/8"	F IFR8 3/8 BSP	Female 800200048	6,3	G3/8"	G	G = F+D-15	G = F+D-0.59	F	56,2	2,21	C	27,0	1,06	M	40,0	1,57	I	30,0	1,18	E	44,0	1,73
3/8"	F IFR8 1/2 BSP	Female 800200050	6,3	G 1/2"	G	G = F+D-15	G = F+D-0.59	F	59,2	2,33	C	27,0	1,06	M	40,0	1,57	I	30,0	1,18	E	44,0	1,73
3/8"	F IFR8 M18X1.5	Female 800212000	6,3	M18X1.5	G	G = F+D-15	G = F+D-0.59	F	54,2	2,13	C	27,0	1,06	M	40,0	1,57	I	30,0	1,18	E	44,0	1,73

Descriptive Code	Item Code	Weight	
		Kg	Lbs
F IFR8 3/8 BSP	Female 800200048	0,36	0,80
F IFR8 1/2 BSP	Female 800200050	0,43	0,94
F IFR8 M18X1.5	Female 800212000	0,36	0,80

### Port description: MALE THREAD BSP (DIN 3852-2 form A) MALE THREAD METRIC L series 24° (ISO 8434-1 & DIN 2353)

BODY SIZE	Descriptive Code	Item Code	ISO DN	PORT (A)	Overall Length		Length		Length		Hex		Hex		Diameter							
					mm	inch	mm	inch	mm	inch	mm	inch	mm	inch	mm	inch						
3/8"	M IFR8 1/2 BSP EST	Male 800200051	6,3	G 1/2"	G	G = F+D-15	G = F+D-0.59	D	49,1	1,93	L	14,0	0,55	B	27,0	1,06	P	32,0	1,26	T	35,0	1,38
3/8"	M IFR8 L12 SCHOTT 23	Male 800210003	6,3	M18X1.5	G	G = F+D-15	G = F+D-0.59	D	58,1	2,29	L	23,0	0,91	B	27,0	1,06	P	32,0	1,26	T	35,0	1,38
3/8"	M IFR8 M20X1,5 EST	Male 800215003	6,3	M20X1.5	G	G = F+D-15	G = F+D-0.59	D	58,1	2,29	L	23,0	0,91	B	27,0	1,06	P	32,0	1,26	T	35,0	1,38

Descriptive Code	Item Code	Diameter		Diameter		Weight			
		mm	inch	mm	inch	Kg	Lbs		
M IFR8 1/2 BSP EST	Male 800200051	H	30,0	1,18	J	29,0	1,14	0,19	0,42
M IFR8 L12 SCHOTT 23	Male 800210003	H	30,0	1,18	J	29,0	1,14	0,19	0,43
M IFR8 M20X1,5 EST	Male 800215003	H	30,0	1,18	J	29,0	1,14	0,20	0,44

OTHER INTERCHANGE



## PROTECTIVE CAPS FOR IFR SERIES

Protective caps are always recommended to protect the couplings from damage, dirt inclusion, and will increase the product life. This is particularly important in agricultural applications where exposure to weather and aggregate materials are common.

**Metallic plug for female and plastic cap for male are included with the IFR couplings.**

- The plug for female coupling is in carbon steel Cr III zinc plated.
- The standard color of plastic cap for male coupling is Yellow.
- Temperature range: from -20°C to +100°C.

**Plug for FEMALE coupling**  
Carbon steel

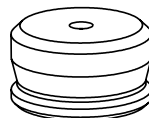

**Cap for MALE coupling**  
Yellow plastic

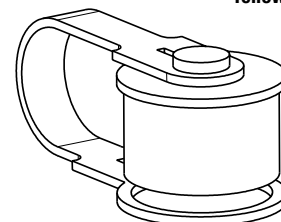

Protective Cap			
Body Size/Description		Part Number	
		Metallic plug for Female	Plastic cap for Male
3/8"	IFR8	815701120	814901027